

4

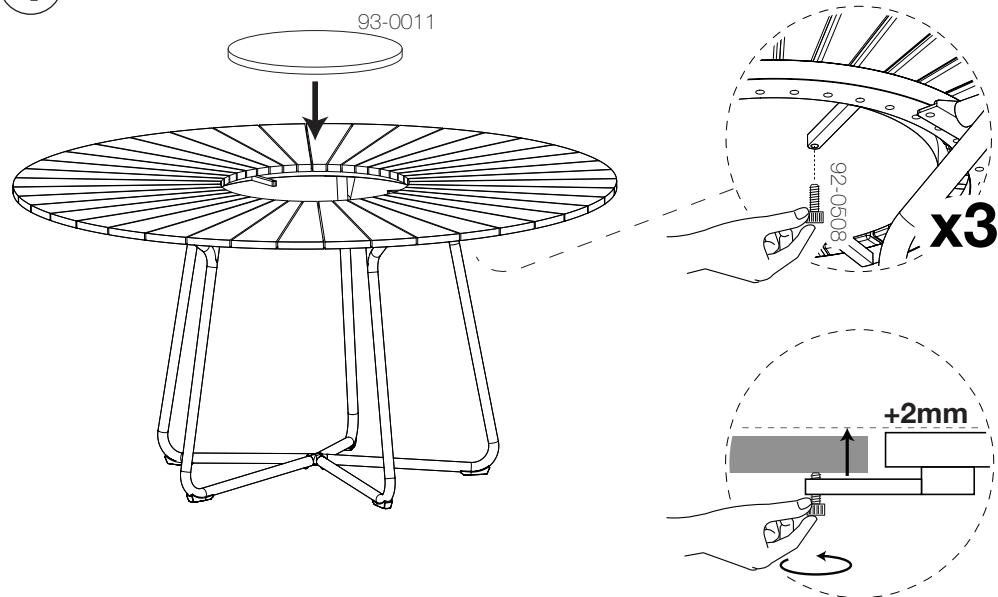

Bamboo treatment

The bamboo on your product are treated with a special impregnation from the factory. To keep the product nice it is necessary to treat the bamboo on a regular basis with oil suitable for bamboo. We recommend you to oil the product before taking it into use, and again after approx. 4 weeks, then as needed (3 – 4 times a year)

Fungi can attack all wooden furniture that is placed outside. Once fungi have attacked the bamboo it is possible to clean it by sanding the bamboo down with sandpaper and oil it again.

It is very important that you do not oil the bamboo if there is the slightest sign of infestation of fungi. Oiling at this stage will worsen the problem. We recommend oil suitable for outdoor bamboo furniture containing fungicide. Fungicide is an anti-fungal agent.

For daily cleaning it is recommended to only use hot water, as soapy water dissolves the oil. Outside the season, store in a dry and ventilated room. Do not cover the bamboo, as bamboo is a natural material that needs air to avoid that fungi and mold will spread into the material.

Removing fungi and damaged surface:

- Make the bamboo surface wet, and scrub with a stiff brush. This cleans deep into the bamboo, and removes grime and fungi. A small amount of soap can, if necessary, be used.
- When the bamboo is dry, use a power sander to sand down the bamboo, just like a solid wood treatment. Start with a medium-coarse sandpaper, and when the desired removal is achieved, step up to a fine sandpaper to finish the surface. Make sure to sand the bamboo evenly everywhere.
- After cleaning and sanding, it is important that the surface of the bamboo is sealed immediately with oil again. Apply according to the instructions on the product label, making sure not to apply more than necessary. Let the oil dry for 24 hours before use.

Powdercoated metal parts

For cleaning please use a wet cloth or a soft brush. Do not use any kind of chemicals for cleaning.

HOUE

CIRCLE Ø150

DESIGN BY
HENRIK PEDERSEN

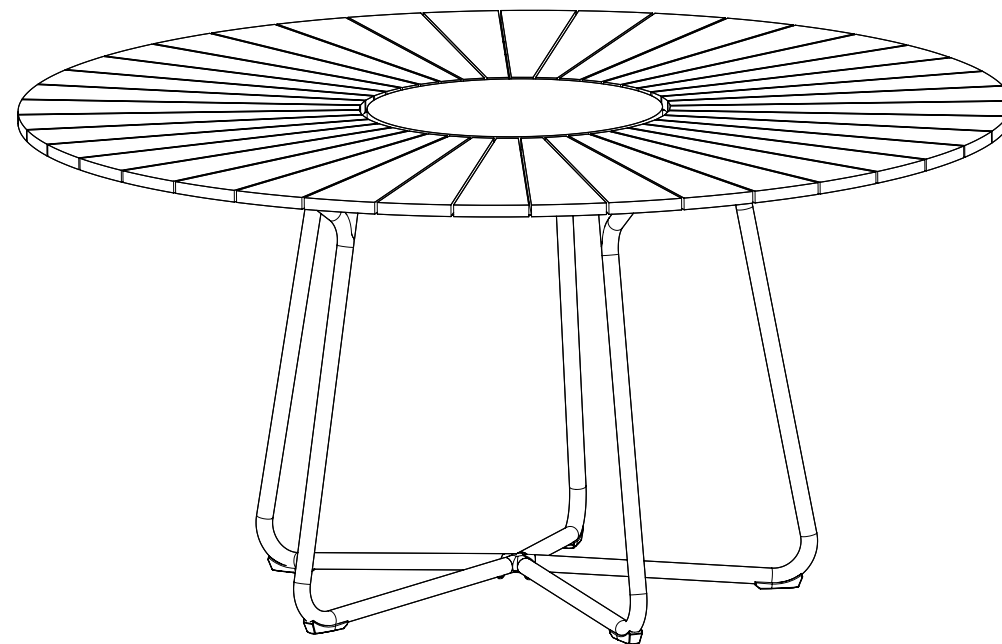

ASSEMBLY INSTRUCTIONS

97-4008-V5

